

CATÁLOGO
IFHT / IFFT





LIDERAZGO E INNOVACIÓN

IFHT / IFFT

Ventilador centrífugo de impulso tipo Jet Fan, diseñado para mover grandes volúmenes de aire en estacionamientos y túneles.

Modelo IFHT capacitados para trabajar inmersos a 400°C / 2h y 300 °C / 2h para extracción de humos en caso de emergencias y para reducción de los niveles de contaminación en estacionamientos subterráneos.

Modelo IFFT diseñados para mover grandes volúmenes de aire contaminados a temperatura ambiente.

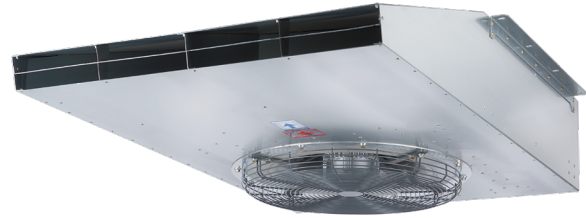

Homologados según norma EN12101-3. Certificación n° 0379-CPD-1250



Homologados según norma EN12101-3. Certificación n° 0379-CPD-1085



Consulta la App para conocer el funcionamiento de estos equipos.

CARACTERÍSTICAS

- Fuerza de empuje 50,75 y 100N.
- Hélice de álabes hacia atrás de acero galvanizado, balanceada de acuerdo con la ISO 1940-1 G6.3.
- Carcasa de acero galvanizado, con dos soportes de sujeción.
- Caja de bornes o interruptor de acuerdo a solicitud.
- Rejilla de protección en la aspiración
- Ventilador homologado según norma EN12101-3, para 400 °C/2h y 300 °C/2h.
- Motores trifásicos con índice de protección IP55.
- Temperatura ambiente de trabajo -20°C a 40°C.

APLICACIONES

EXTRACCIÓN DE CONTAMINANTES HABITUALES

DISIPACIÓN DE HUMO

ESTACIONAMIENTOS

TÚNELES DE ACCESO

EXTRACCIÓN DE HUMO EN EMERGENCIA

NOMENCLATURA IFHT

Modelo	Modelo Número de polos	Empuje	Potencia motor KW	Temperatura Motor	Voltaje Motor V	Conexión Eléctrica
IFHT= Alta temperatura	4/8	50	1.5/0.21	3 = 300°C	230	Caja de Bornes = C
	4/8	75	2.5/0.45	4 = 400°C	460	Interruptor 300°C = I3
	4/8	100	2.5/0.45		380	Interruptor 400°C = I4

NOMENCLATURA IFFT

Modelo	Modelo Número de polos	Empuje	Potencia motor KW	Voltaje Motor V
IFFT= Alta temperatura	4/8	50	1.5/0.21	230
	4/8	75	2.5/0.45	460
	4/8	100	2.5/0.45	380



CARACTERÍSTICAS TÉCNICAS IFHT

Modelo	No. De polos	Empuje	Potencia motor KW	Temperatura motor	Voltaje Motor V	Conexión Eléctrica	Velocidad RPM	Empuje N	Caudal m³/h/CFM	Intensidad A	Presión sonora dBA	Peso aprox Kg
IFHT	4/8	50	1.5/0.21	300°C	230	Caja de Bornes	1677 / 589	3.6	5,750/3,384	6.38/2.09	75/59	76
			1.5/0.21	300°C	460	Caja de Bornes				3.19/1.04		
			1.5/0.21	300°C	380	Caja de Bornes				3.86/1.26		
			1.5/0.21	300°C	230	Interruptor 300°C				6.38/2.09		
			1.5/0.21	300°C	460	Interruptor 300°C				3.19/1.04		
			1.5/0.21	300°C	380	Interruptor 300°C				3.86/1.26		
			1.5/0.21	400°C	230	Caja de Bornes				5.79/2.31		
			1.5/0.21	400°C	460	Caja de Bornes				3.24/0.978		
			1.5/0.21	400°C	380	Caja de Bornes				3.92/1.18		
			1.5/0.21	400°C	230	Interruptor 400°C				5.79/2.31		
			1.5/0.21	400°C	460	Interruptor 400°C				3.24/0.978		
			1.5/0.21	400°C	380	Interruptor 400°C				3.92/1.18		
IFHT	4/8	75	2.5/0.45	300°C	230	Caja de Bornes	1735/880	75/19	8,100/4,768	9.61/3.09	77/61	120
			2.5/0.45	300°C	460	Caja de Bornes				5.12/1.61		
			2.5/0.45	300°C	380	Caja de Bornes				6.20/1.95		
			2.5/0.45	300°C	230	Interruptor 300°C				9.61/3.09		
			2.5/0.45	300°C	460	Interruptor 300°C				5.12/1.61		
			2.5/0.45	300°C	380	Interruptor 300°C				6.20/1.95		
			2.5/0.45	400°C	230	Caja de Bornes				8.54/3.09		
			2.5/0.45	400°C	460	Caja de Bornes				4.61 / 1.61		
			2.5/0.45	400°C	380	Caja de Bornes				5.59/1.95		
			2.5/0.45	400°C	230	Interruptor 400°C				8.54/3.09		
			2.5/0.45	400°C	460	Interruptor 400°C				4.61 / 1.61		
			2.5/0.45	400°C	380	Interruptor 400°C				5.59/1.95		
IFHT	4/8	100	2.5/0.45	300°C	230	Caja de Bornes	1735/880	95/24	8,900/5,238	9.61/3.09	78/63	120
			2.5/0.45	300°C	460	Caja de Bornes				5.12/1.61		
			2.5/0.45	300°C	380	Caja de Bornes				6.20/1.95		
			2.5/0.45	300°C	230	Interruptor 300°C				9.61/3.09		
			2.5/0.45	300°C	460	Interruptor 300°C				5.12/1.61		
			2.5/0.45	300°C	380	Interruptor 300°C				6.20/1.95		
			2.5/0.45	400°C	230	Caja de Bornes				8.54/3.09		
			2.5/0.45	400°C	460	Caja de Bornes				4.61 / 1.61		
			2.5/0.45	400°C	380	Caja de Bornes				5.59/1.95		
			2.5/0.45	400°C	230	Interruptor 400°C				8.54/3.09		
			2.5/0.45	400°C	460	Interruptor 400°C				4.61 / 1.61		
			2.5/0.45	400°C	380	Interruptor 400°C				5.59/1.95		

CARACTERÍSTICAS TÉCNICAS IFFT

Modelo	Potencia motor KW	No. De Polos	Voltaje Motor V	Conexión Eléctrica	Velocidad RPM	Empuje N	Caudal m³/h/CFM	Presión sonora dB (A)	Peso aprox Kg
IFFT-4/8-50N	1.5/0.21	4/8	230	Interruptor	1690/855	50/13	5,750/3,384	75/58	76
			460						
			380						
IFFT-4/8-75N	2.5/0.45	4/8	230	Interruptor	1730/875	75/19	8100/4768	77/61	120
			460						
			380						
IFFT-4/8-100N	2.5/0.45	4/8	230	Interruptor	1730/875	95/24	8900/5238	78/63	120
			460						
			380						

*Presión sonora a 3 metros en campo libre.

*Los valores de velocidad y potencia son nominales.

CARACTERÍSTICAS ACÚSTICAS

IFHT / IFFT (4 polos)

Modelo	63	125	250	500	1000	2000	4000	8000	LwA
50	61	79	84	87	87	85	80	73	93
75	63	83	85	87	89	85	80	73	94
100	65	83	87	90	91	87	81	74	95

IFHT / IFFT (8 polos)

Modelo	63	125	250	500	1000	2000	4000	8000	LwA
50	46	64	69	72	72	70	65	58	76
75	48	68	70	72	74	70	65	58	78
100	50	68	72	75	76	72	66	59	80

*Nivel sonoro medido de acuerdo con las normas AMCA 300 y 301

DIMENSIONALES

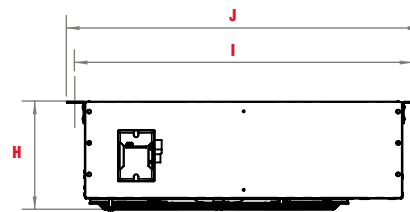
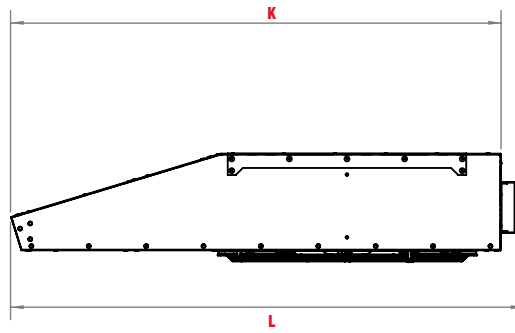
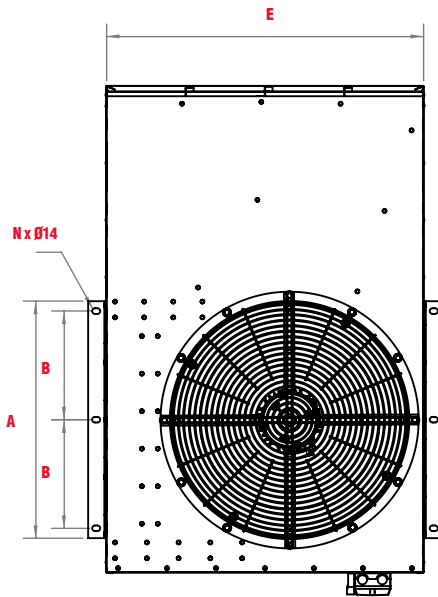

Modelo	A	B	E	H	I	J	K	L	N
IFHT / IFFT -4/8-50N	600	275	800	272	844	890	1232	1298	3

Dimensiones en mm.

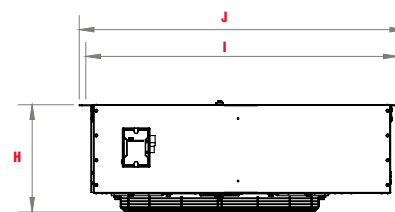
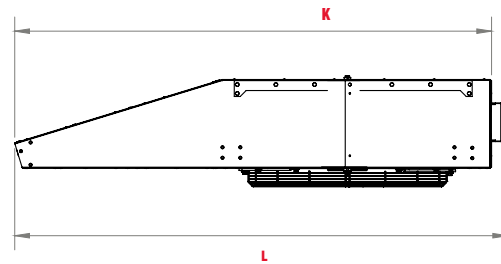
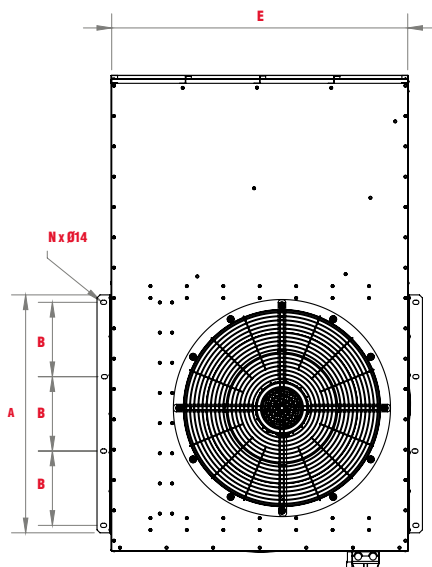

Modelo	A	B	E	H	I	J	K	L	N
IFHT/ IFFT -4/8-75N	800	250	1000	337	1044	1090	1600	1666	4
IFHT/IFFT -4/8-100N	800	250	1000	337	1044	1090	1600	1666	4

Dimensiones en mm.

IFHT-50 4P

IFHT-50 4P	
Distancia m	VELOCIDAD m/s
0	16.271
2	4.967
4	4.431
6	3.926
8	3.585
10	3.125
12	2.716
14	2.388
16	2.234
18	2.176
20	2.097
22	2.001
24	1.91
26	1.845
28	1.76
30	1.685
32	1.62
34	1.561
36	1.519
38	1.466
40	1.416
42	1.372
44	1.337
46	1.316
48	1.295
50	1.273

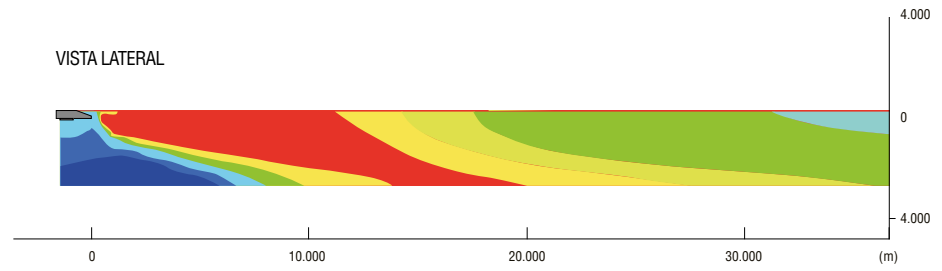

VISTA PLANTA

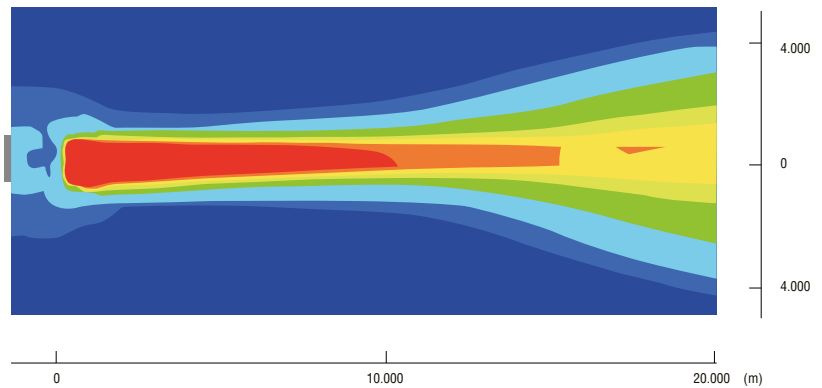

Impulso máximo calculado de acuerdo a ASHRAE Standard 70.

Datos obtenidos a condiciones estándar a máxima velocidad de operación

Velocidad: m/s Distancia: m

IFHT-50 8P

IFHT-50 8P	
Distancia m	VELOCIDAD m/s
0	7.834
2	2.476
4	2.177
6	1.899
8	1.723
10	1.494
12	1.284
14	1.138
16	1.077
18	1.045
20	1.004
22	0.963
24	0.918
26	0.886
28	0.894
30	0.817
32	0.789
34	0.762
36	0.741
38	0.715
40	0.694
42	0.681
44	0.665
46	0.649
48	0.628
50	0.611

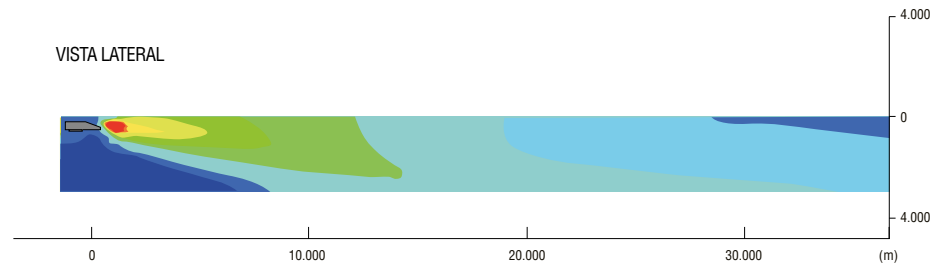

VISTA PLANTA

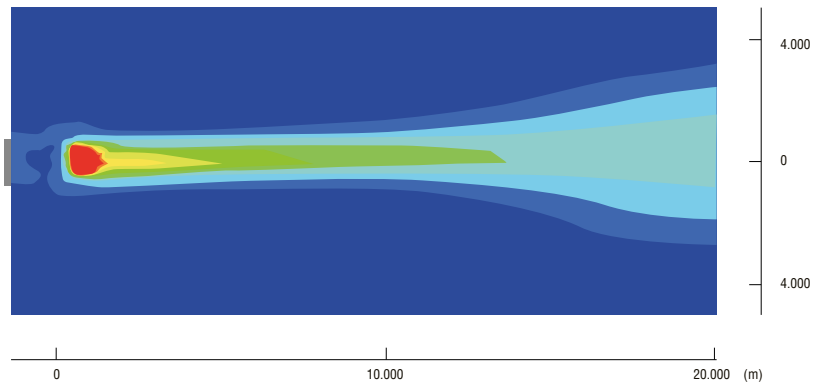

Impulso máximo calculado de acuerdo a ASHRAE Standard 70.

Datos obtenidos a condiciones estándar a máxima velocidad de operación

Velocidad: m/s Distancia: m

IFHT-75 4P

IFHT-75 4P	
Distancia m	VELOCIDAD m/s
0	21.582
2	9.08
4	7.8
6	5.831
8	4.352
10	3.854
12	3.606
14	3.456
16	3.353
18	3.284
20	3.183
22	3.045
24	2.898
26	2.751
28	2.609
30	2.492
32	2.368
34	2.252
36	2.152
38	2.06
40	1.986
42	1.911
44	1.842
46	1.781
48	1.727
50	1.685

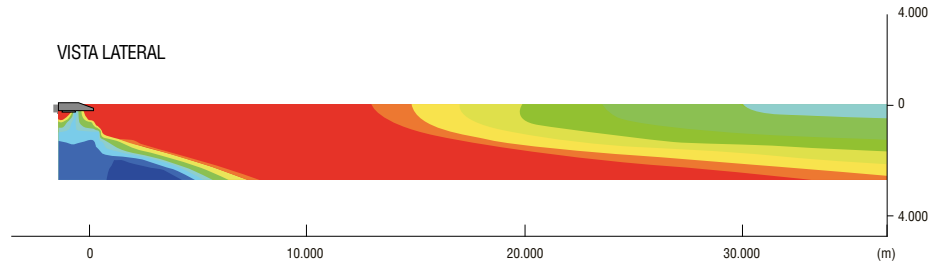

VISTA PLANTA

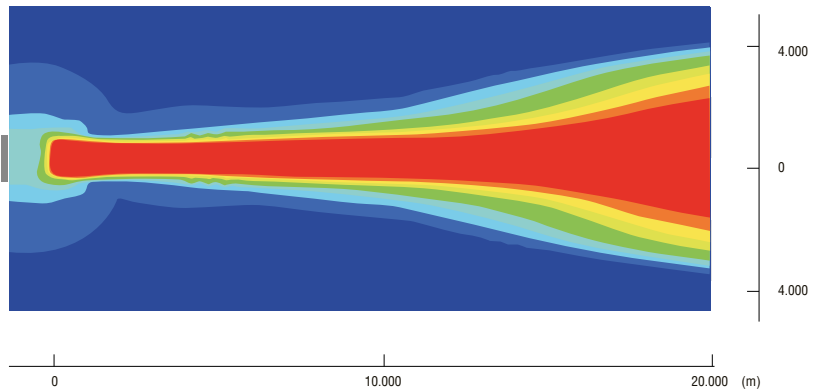

Impulso máximo calculado de acuerdo a ASHRAE Standard 70. Datos obtenidos a condiciones estándar a máxima velocidad de operación

Velocidad: m/s Distancia: m

IFHT-75 8P

IFHT-75 8P	
Distancia m	VELOCIDAD m/s
0	10.848
2	4.541
4	3.902
6	2.904
8	2.17
10	1.921
12	1.798
14	1.729
16	1.671
18	1.636
20	1.586
22	1.517
24	1.444
26	1.371
28	1.301
30	1.243
32	1.181
34	1.125
36	1.074
38	1.028
40	0.991
42	0.953
44	0.919
46	0.888
48	0.861
50	0.839

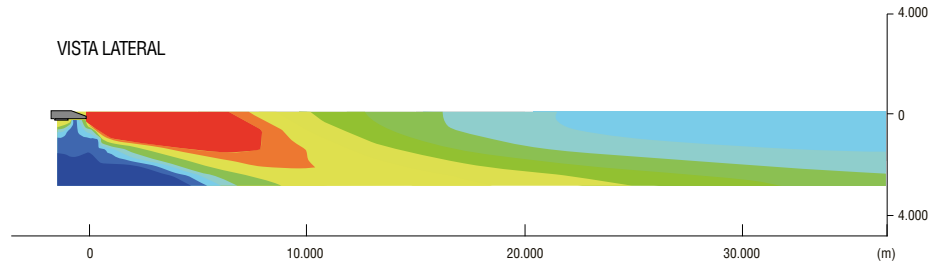

VISTA PLANTA

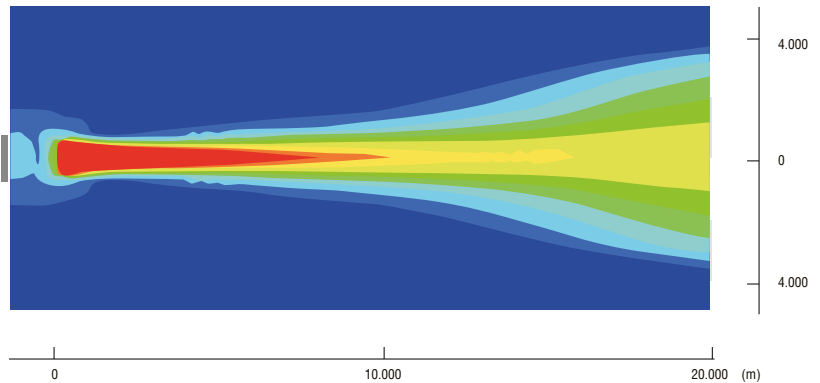

Impulso máximo calculado de acuerdo a ASHRAE Standard 70. Datos obtenidos a condiciones estándar a máxima velocidad de operación

Velocidad: m/s Distancia: m

IFHT-100 4P

IFHT-100 4P	
Distancia m	VELOCIDAD m/s
0	23.977
2	9.977
4	8.569
6	6.382
8	4.768
10	4.219
12	3.952
14	3.801
16	3.678
18	3.604
20	3.495
22	3.345
24	3.184
26	3.023
28	2.866
30	2.738
32	2.601
34	2.476
36	2.364
38	2.263
40	2.184
42	2.102
44	2.028
46	1.962
48	1.902
50	1.854

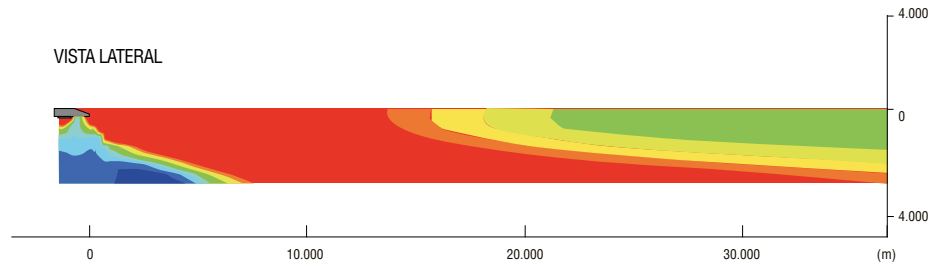

VISTA PLANTA

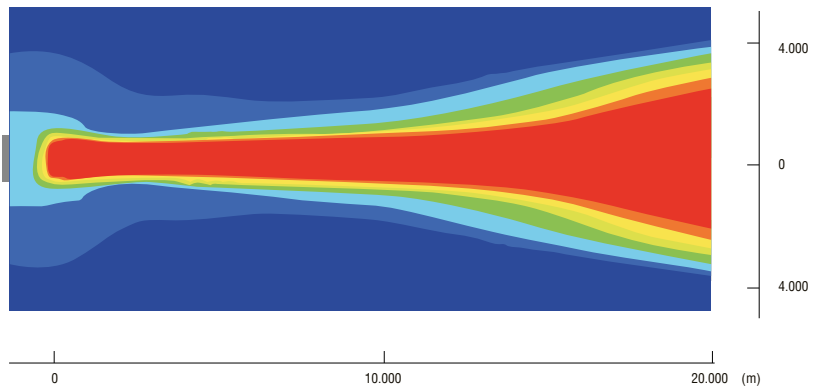

Impulso máximo calculado de acuerdo a ASHRAE Standard 70.

Datos obtenidos a condiciones estándar a máxima velocidad de operación

Velocidad: m/s Distancia: m

IFHT-100 8P

IFHT-100 4P	
Distancia m	VELOCIDAD m/s
0	11.963
2	4.982
4	4.236
6	3.18
8	2.384
10	2.109
12	1.974
14	1.899
16	1.834
18	1.798
20	1.743
22	1.668
24	1.587
26	1.506
28	1.429
30	1.365
32	1.297
34	1.235
36	1.179
38	1.129
40	1.089
42	1.048
44	1.011
46	0.977
48	0.946
50	0.922

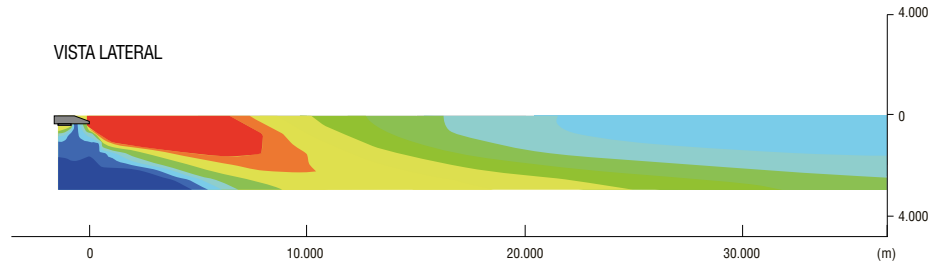

VISTA PLANTA

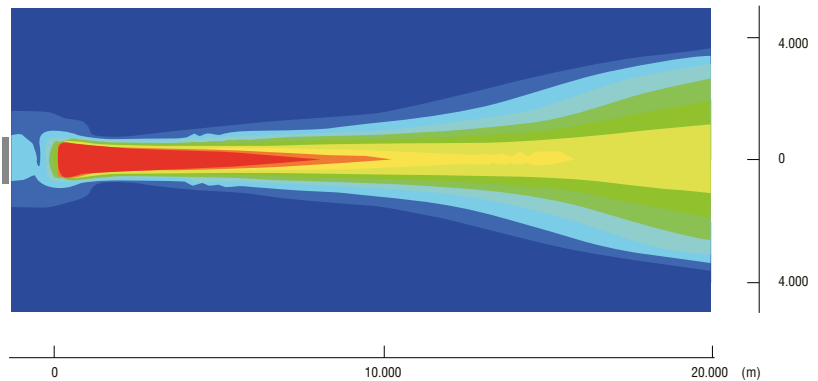

Impulso máximo calculado de acuerdo a ASHRAE Standard 70.

Datos obtenidos a condiciones estándar a máxima velocidad de operación

Velocidad: m/s Distancia: m

CONEXIONES ELÉCTRICAS

IFHT



Interruptor Alta temperatura

Interruptor paro-marcha de seguridad IP 65,
F400 ó F 300.

IFHT

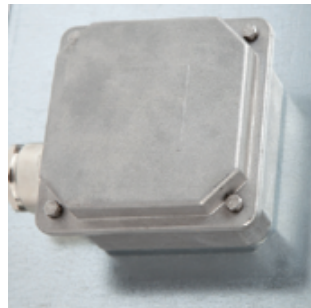

Cajas de bornes

Caja de conexiones exterior IP 65 para facilitar
la instalación

IFFT



Interruptor

Interruptor en carcasa de policarbonato
rígido IP 65.



S&P México

Tel. 52 (222) 2 233 911, 2 233 900
comercialmx@solerpalau.com

S&P Colombia

PBX: (+571 743 8021)
comercial@solerpalau.com.co

S&P Perú

Tel. +51 (1) 200 9020
comercialpe@solerpalau.com



WWW.SOLERPALAU.MX